

DATAMAN 470 SERIES BARCODE READERS

Premium fixed-mount barcode readers
for the most challenging applications



COGNEX

DATAMAN 470 SERIES BARCODE READERS

Premium fixed-mount barcode readers for the most challenging applications

DataMan 470 series fixed-mount barcode readers solve complex, high-throughput manufacturing and logistics applications with ease. DataMan 470's multi-core processing power, new HDR+ imaging technology, high-resolution sensor, advanced algorithms, and simple setup delivers maximum coverage, speed, and ease-of-use.

DataMan 470 excels at reading a wide range of codes including:

- Challenging 1D, 2D, and direct part mark (DPM) codes
- Multiple 1D and 2D codes with mixed symbologies
- Small Data Matrix codes
- Severely damaged 1D codes



Fast, powerful performance solves challenging applications

The DataMan 470 barcode reader has seven powerful processing cores, enabling it to run multiple algorithms and processes in parallel at astonishing speeds. It reads challenging 1D and 2D codes in varied locations, as well as multiple mixed symbologies simultaneously while maintaining the highest decode rates.



High-Speed Code Reading

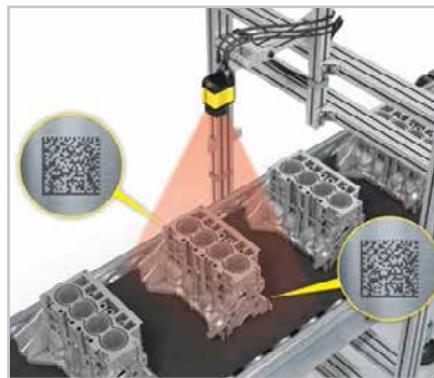

Varied Location Code Reading



Mixed Symbology, Multi-Code Reading

New imaging technology for advanced image formation



High Dynamic Range (HDR) imaging uses the latest CMOS image sensor technology which is 16x more detailed than conventional sensors. HDR takes advantage of the extra available image data to globally enhance image quality and contrast.

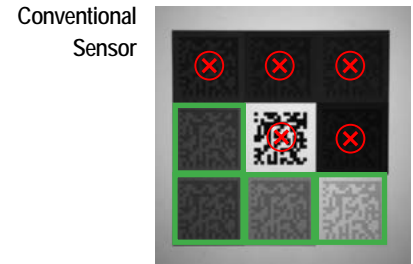

HDR+ is an advanced, patent-pending algorithm that stretches the boundaries of HDR technology by further increasing localized contrast changes automatically. This creates a more uniformed image in a single acquisition allowing greater depth-of-field, faster line speeds, and improved handling of difficult codes.

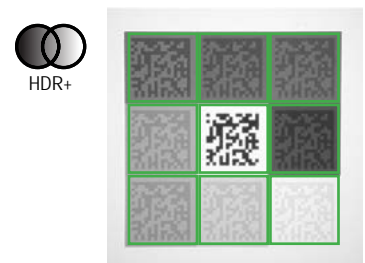
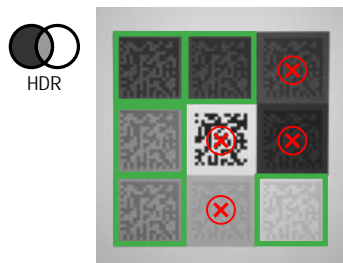

HDR+ technology enables DataMan 470 to read an increased range of codes than is possible with conventional or other HDR technologies.

Greater Depth-of-Field

HDR+ reduces over- and under-exposure, providing greater depth-of-field, above and beyond HDR technology and conventional imaging sensors.

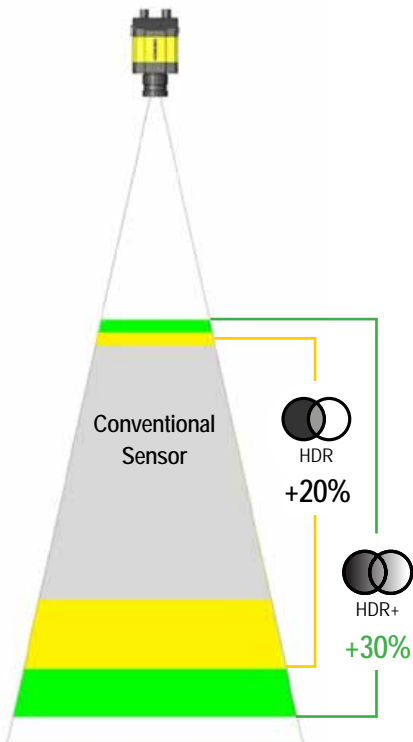

Faster Line Speeds

HDR+ significantly reduces exposure times, increasing line speed possibilities by more than 80%.

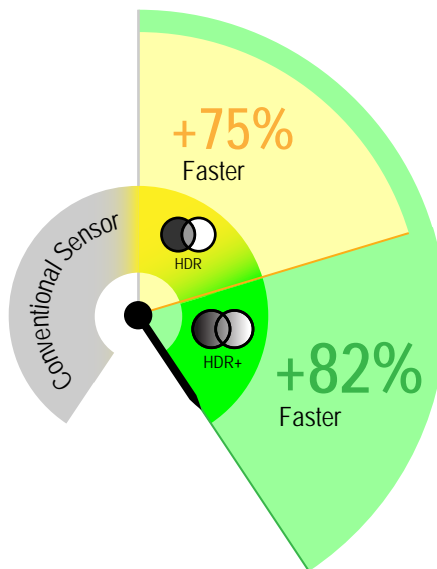

Improved Code Handling

HDR+ allows DataMan 470 to adjust contrast ranges to read difficult codes with variant backgrounds that cannot be read with conventional technology.

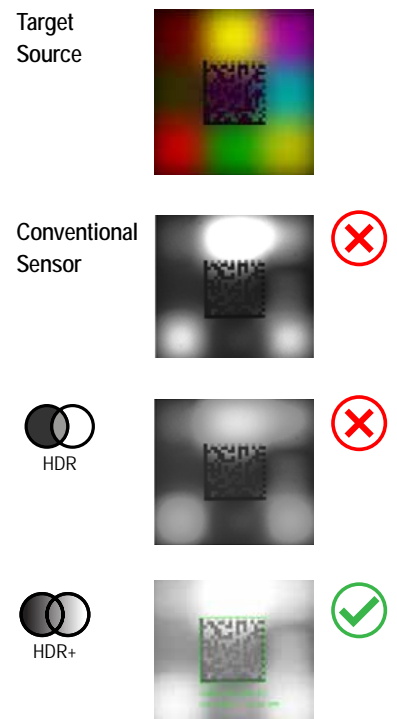

99.9% read rates for optimal throughput and traceability

DataMan 470 series is optimized with patented technologies and advanced algorithms to ensure continuously high read rates of 1D and 2D symbologies, regardless of size, quality, printing method, or surface.



1DMax Advanced Algorithm

1D barcode reading algorithm is optimized for omnidirectional barcode reading and extreme variations in contrast, blur, damage, resolution, quiet zone violations, and perspective distortion.

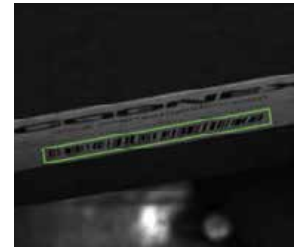
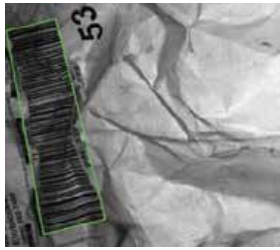

2DMax Advanced Algorithm

2D barcode reading algorithm provides reliable 2D code reading despite code quality, printing method, or surface type.



Hotbars Image Analysis Technology

Hotbars technology locates and extracts 1D barcodes up to 10x faster than a typical reader, even with increased noise, large specular reflection, reduced quiet zone, limited contrast, and damage.

	TYPICAL 1D ALGORITHM	HOTBARS IMAGE ANALYSIS
Noise		
Specularity		
Perspective		
Quiet Zone		
Contrast		
Damage		



PowerGrid Technology

PowerGrid technology quickly locates 2D codes that exhibit significant damage to or complete elimination of a code's finder pattern, clocking pattern, or quiet zone.



No finder pattern



No finder or
clocking pattern



Quiet zone
violation



Stripe



Modular options provide maximum flexibility

DataMan 470's innovative design with modular lighting, lens, and communication options adjusts to solve any barcode reading application.



RS-232, Ethernet with industrial protocols, SD card, and other network connectivity options



S-mount, C-mount, and liquid lens (autofocus) options for maximum application coverage

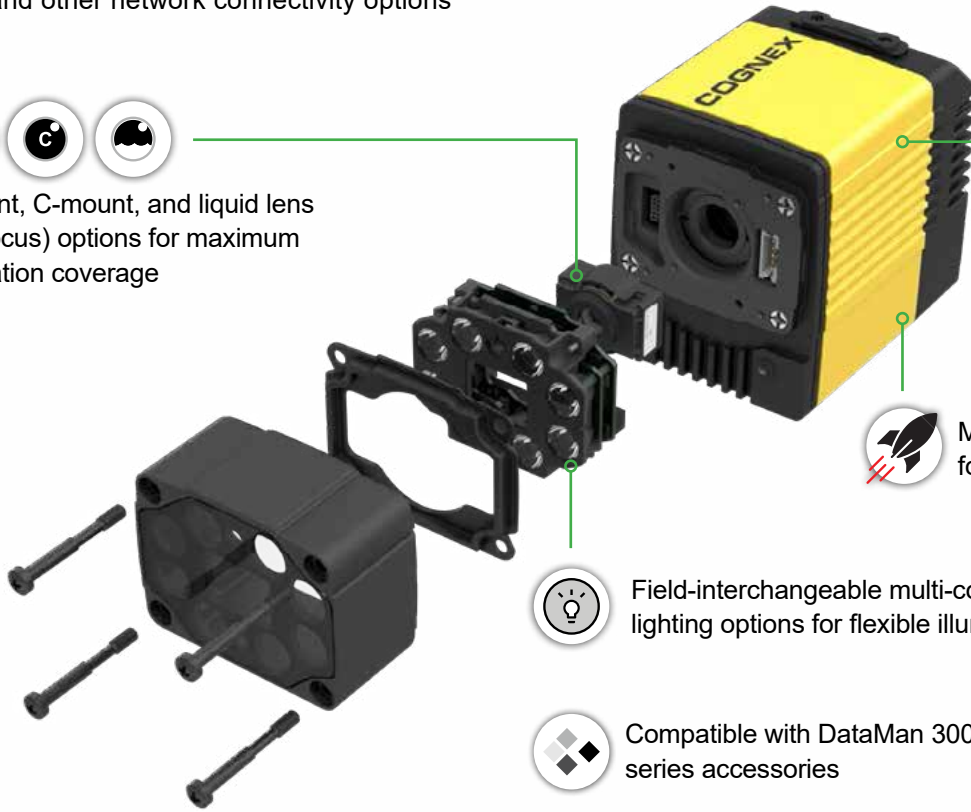

HDR and HDR+ technology for advanced image formation



Multi-core processing power for high speed decoding



Field-interchangeable multi-color and polarization lighting options for flexible illumination



Compatible with DataMan 300/360 series accessories

Model Options	Reads
L	1D fixed position barcodes
QL	1D omnidirectional barcodes
Q	High-speed 1D and 2D codes
X	Challenging 1D and 2D codes, including DPM codes



Performance feedback

DataMan 470 series includes Gigabit Ethernet for fast, full-resolution image transfer to help diagnose the cause of unread codes. Available Cognex Real Time Monitoring (RTM) technology provides performance feedback of DataMan 470 in easy-to-use dashboards to help with process optimization.

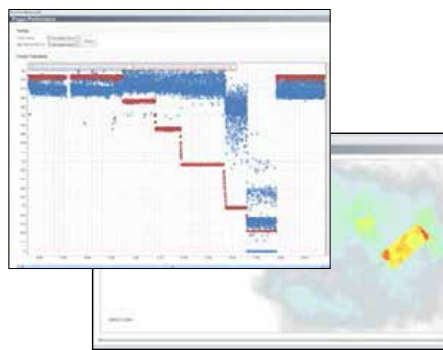

Easy setup and operation

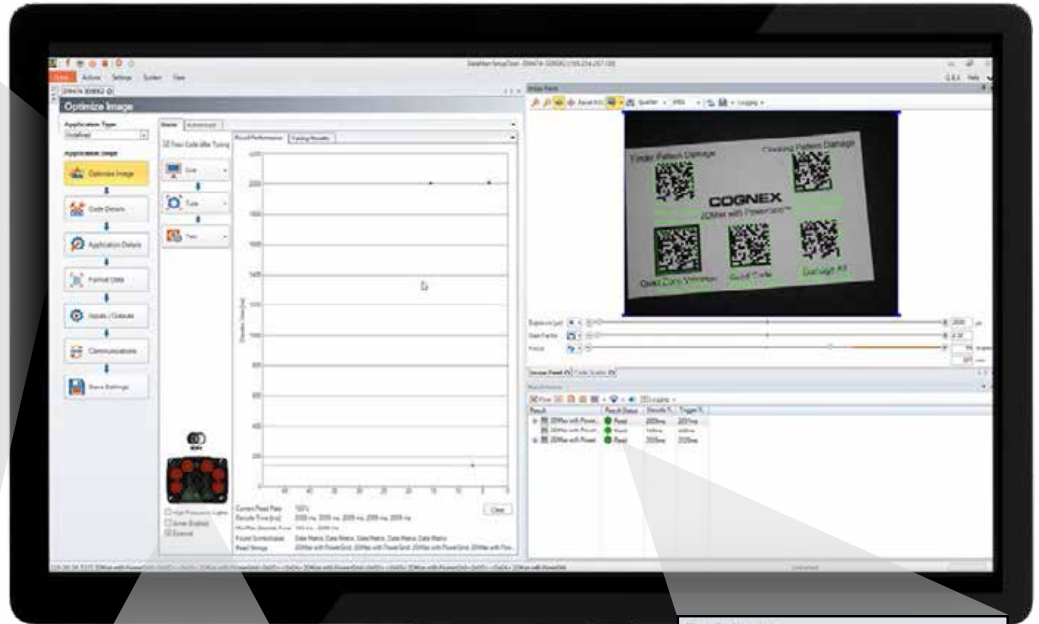
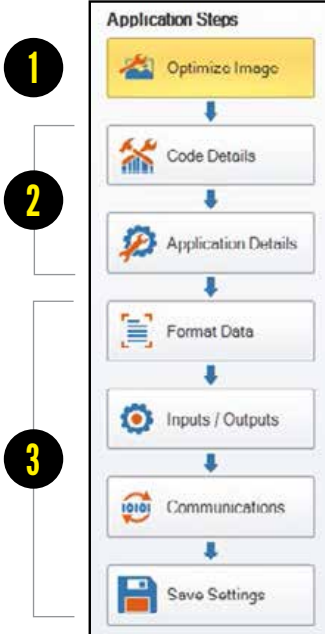

Step-by-step installation flow for easy and efficient setup



Independent light control

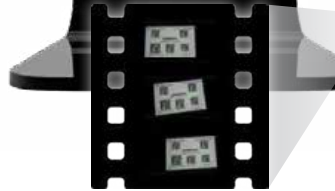

Image transfer

Result	Result Status
2DIAMONDS	Read
2DIAMONDS	Read
2DIAMONDS	Read
2DIAMONDS	Read
2DIAMONDS	Read
2DIAMONDS	Read
2DIAMONDS	Read
2DIAMONDS	Read
2DIAMONDS	Read

Read result history

Application assistants for visual guidance

Application assistants provide basic and advanced visual application guidance, allowing for quick and reliable optimization of complex parameters for simple and challenging applications. Intelligent tuning automatically adjusts lighting, height, and other variable conditions for codes on various parts and surfaces.

Trigger Assistant

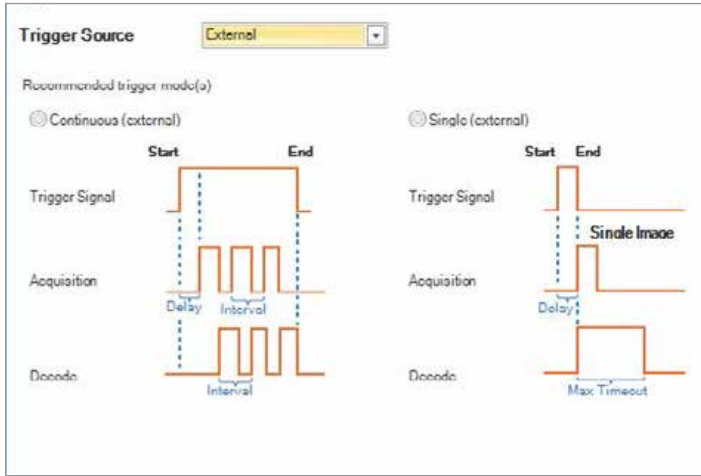

Exposure Assistant

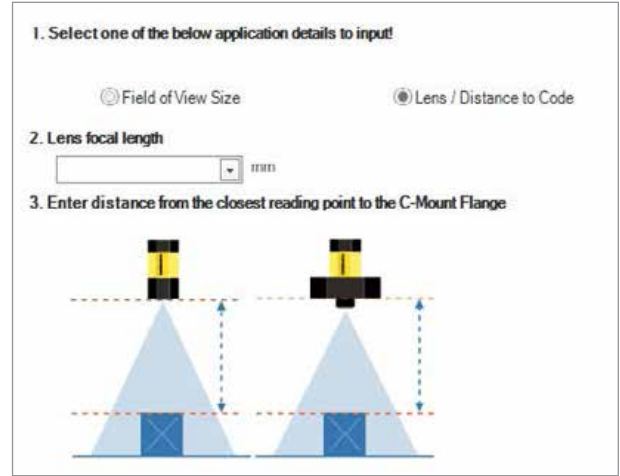

Unprecedented field-of-view coverage with fewer readers

DataMan 470's high-resolution 3.1-megapixel sensor enables greater field-of-view and depth-of-field coverage than other readers. It reads large and small codes from various angles, including high density 2D DPM codes.

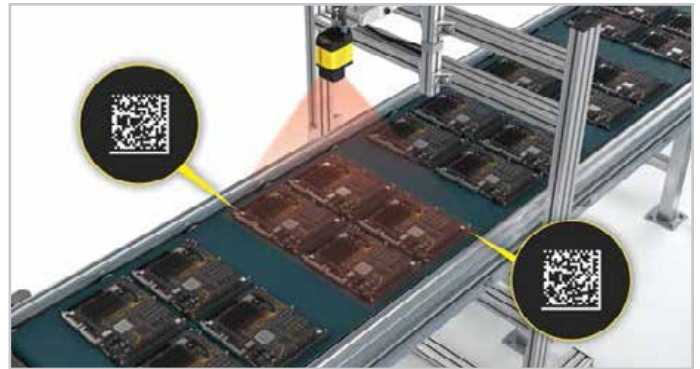
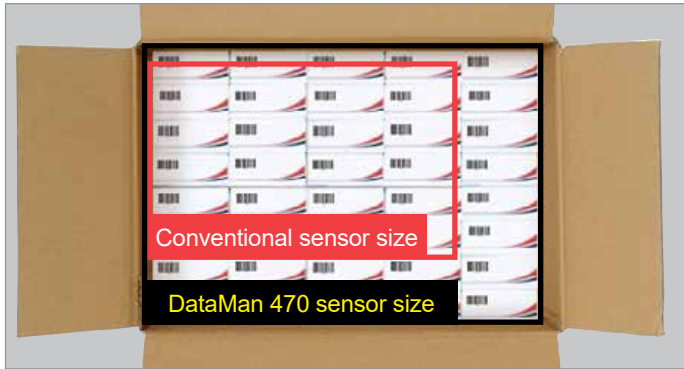

DataMan 470's higher resolution provides expanded field-of-view capabilities to read multiple codes and mixed symbologies with ease.

Increased sensitivity and reduced noise

The new 12-bit CMOS image sensor technology provides greater dynamic range than conventional sensors. With increased sensitivity and reduced noise, DataMan 470 can capture clearer images which are 16x more detailed.



Image taken with conventional 8-bit sensor

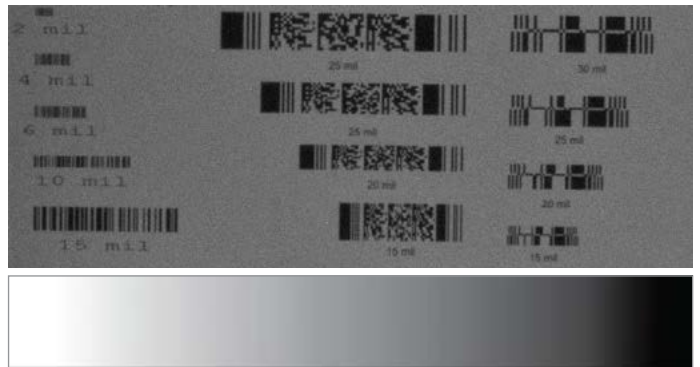
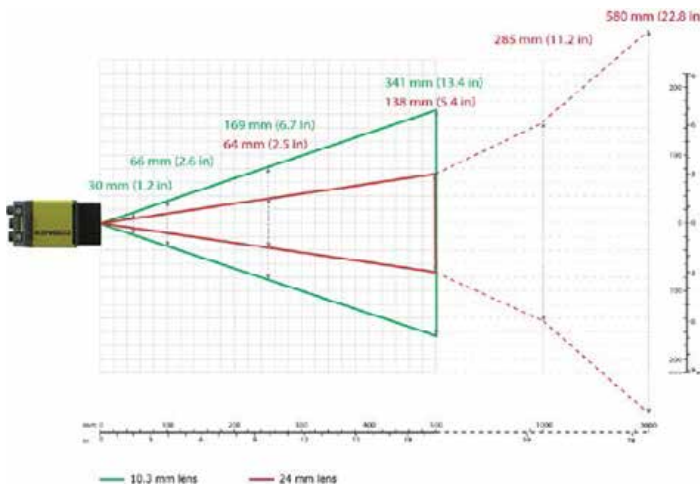

Image taken with DataMan 470 12-bit sensor

DataMan 470 range

A single DataMan 470 barcode reader offers extensive field-of-view and reading distances with liquid lens (autofocus) technology.



Xpand technology

The Xpand technology accessory is also available to increase the field-of-view coverage of a single barcode reader by over 50%.

Single Reader



Single Reader + Xpand Accessory

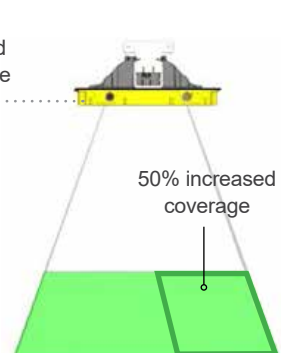

DATAMAN 470 SERIES SPECIFICATIONS

Algorithms and Technologies	1DMax, 2DMax, Hotbars, PowerGrid
Image Sensor	1/1.8" CMOS
Image Sensor Properties	Diagonal 8.9 mm; 3.45 μ m square pixels
Image Sensor Resolution	2048 x 1536
Electronic Shutter Speed	Min. exposure: 15 μ s Max. exposure: 1000 μ s with internal illumination/10000 μ s with external illumination
Max Acquisition	Up to 80 Hz
Lens Options	S-mount 10.3 mm (optional liquid lens), C-mount 24 mm liquid lens, C-mount; 12 mm, 16 mm, 25 mm, 35 mm, 40 mm
Trigger and Tune Buttons	Yes; Quick Setup Intelligent Tuning
Aimer	Optional
Discrete Inputs	2 fixed + (*) opto-isolated
Discrete Outputs	2 fixed + (*) opto-isolated
*Other I/O Points	2 user-configurable
Status Outputs	Beeper, 5 multifunctional LEDs, 10 LED bar array, 360 degree indicator
Lighting	Integrated LEDs, red, blue, or IR; diffuse, polarized, high powered integrated light (HPIL), various controllable external light options
Communications	Ethernet and Serial
Protocols	RS-232, TCP/IP, PROFINET, EtherNet/IP(TM), SLMP, Modbus TCP, NTP, SFTP, FTP, M/S Java Scripting enabled for custom protocols
Power	24 VDC \pm 10%
Power Consumption	24 VDC \pm 10%, 1.5 A maximum (HPIL ¹) 24 VDC, 250 mA maximum (non-HPIL ¹) Supplied by LPS or NEC class 2 only
Weight	373 g
Dimensions	126.8 mm (L) x 60.5 mm (W) x 77.1 mm (H)
Operating Temperature	0–57 °C (32–134.6 °F) ²
Storage Temperature	-20–80 °C (-4–176 °F)
Operating and Storage Humidity	< 95% non-condensing
Protection	IP67 with cables and appropriate lens cover attached
RoHS Certified	Yes
Approvals (CE, UL, FCC)	Yes

¹ HPIL denotes one of the DM360-HPIL-RE or DM360-HPIL-RE-P accessories.

² In situations where the operating temperature exceeds 40 °C, an external heat sink is required.



Αθανασιάδης Χ. - Καλπακίδου Κ. Ο.Ε.

Athanasiadis Ch. - Kalpakidou K. C.O.

Κεντρικό:	Υποκατάστημα:	Main:	Branch:
A. Κοραή 13	Μερόπης 11	13th Ad. Korai str.	11th Meropis str.
57010 Φίλυρο	10441 Κολωνός	57010 Filyro	10441 Kolonos
Θεσ/νίκη - Ελλάδα	Αθήνα - Ελλάδα	Thessaloniki GR	Athens GR
T: +30 2310 672 436	T / Φ: +30 210 515 7861	T: +30 2310 672 436	T / F: +30 210 515 7861
Φ: +30 2310 672 437		F: +30 2310 672 437	

email: contact@robovision.gr, url: www.robovision.gr